

Assembly Instructions Axxis Blow Mold Front Portable Restroom

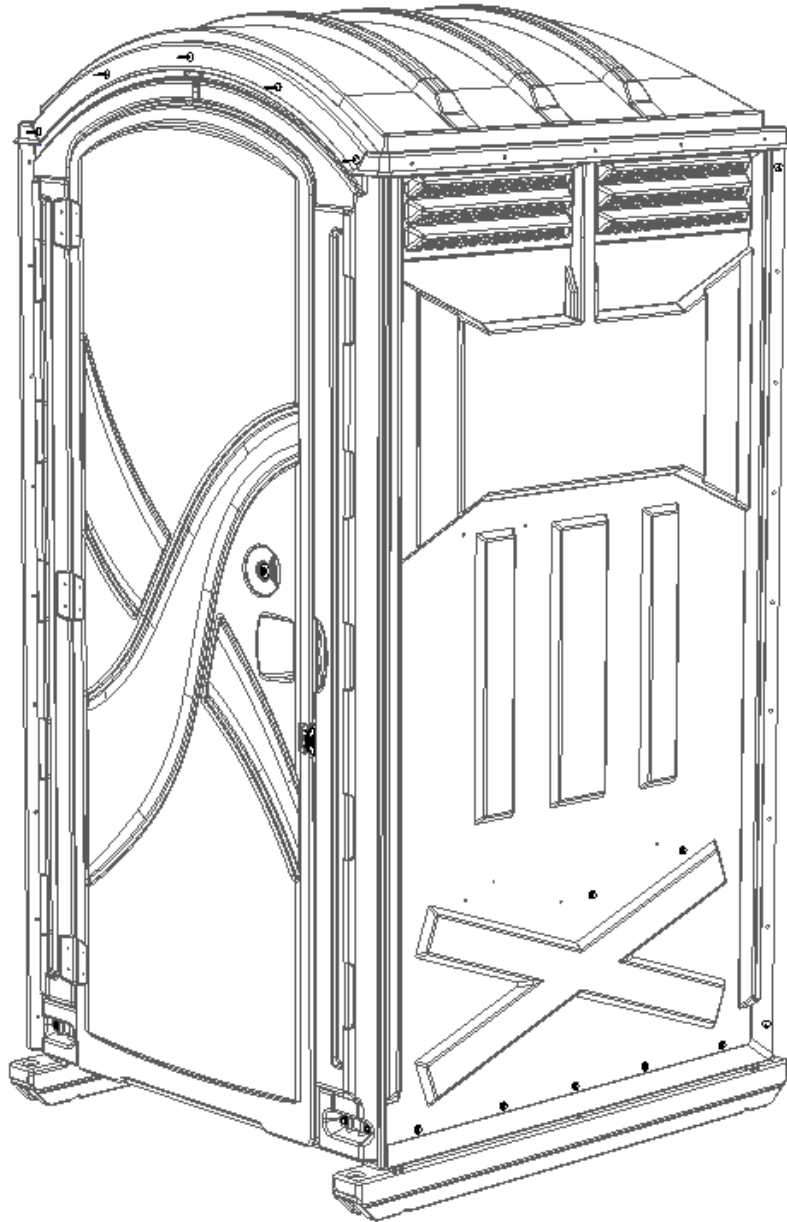

The Most Rugged Portable Restroom and Parts in the Industry!



2530 Xenium Lane North, Minneapolis, MN 55441
Telephone: 763-553-1900 Fax: 763-553-1905
800-328-3332 / www.satelliteindustries.com

INTRODUCTION

Instructions for the Axxis portable restroom (BM) front

Satellite restrooms must be assembled according to approved assembly procedures. Avoid variations in assembly which could adversely affect product life.

The assembly procedures are written for assembly of single units. If assembling multiple units, considerable efficiency can be gained by working in assembly line fashion.

Tools Needed:

●Drill ●#10 Drill Bit ●Rivet Gun ●Phillips Driver bit or Screw Driver ●3/8" Nut Driver bit ●7/16" nut driver or socket ●5/16" nut driver bit

HELPFUL HINTS

- Have an apron with at least two large pockets that allow the parts to be removed easily.
- Don't open up all your kit boxes. Open up only enough kit boxes to assemble the number of toilets you are currently working on. **KEEP PARTS ORGANIZED.**
- Use toilet paper holders for parts bins on multiple unit assembly
- The door latch can be put on at any time. It may be more efficient to have someone do this early on multiple unit assembly.

EXPLODED UNIT ASSEMBLY

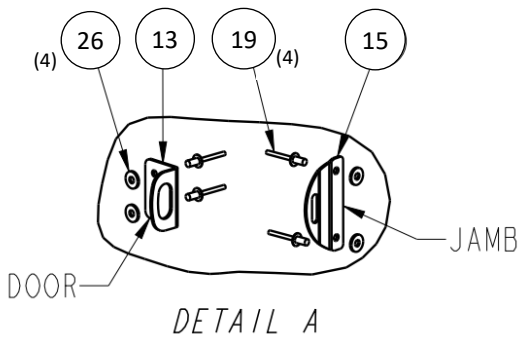
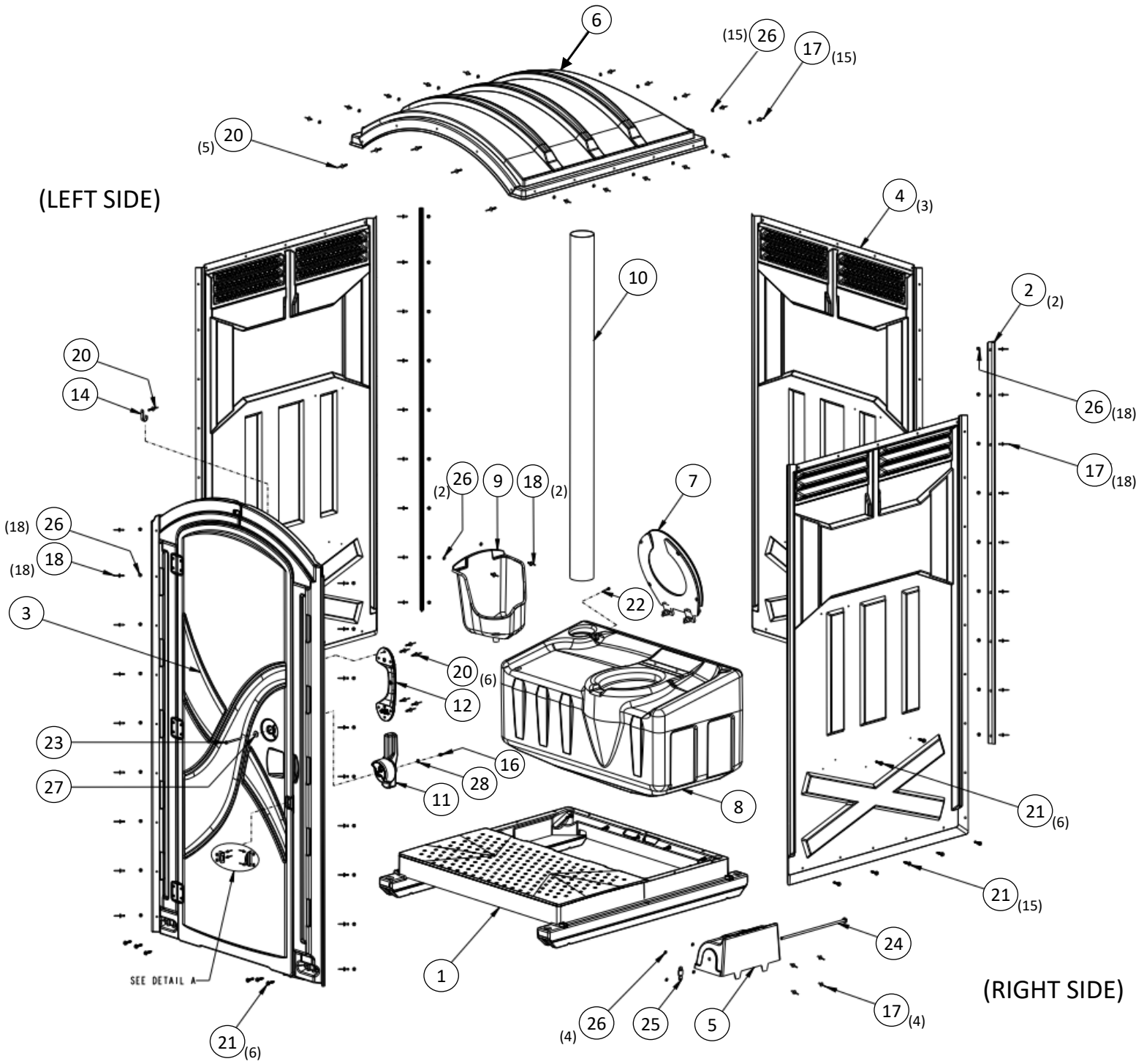

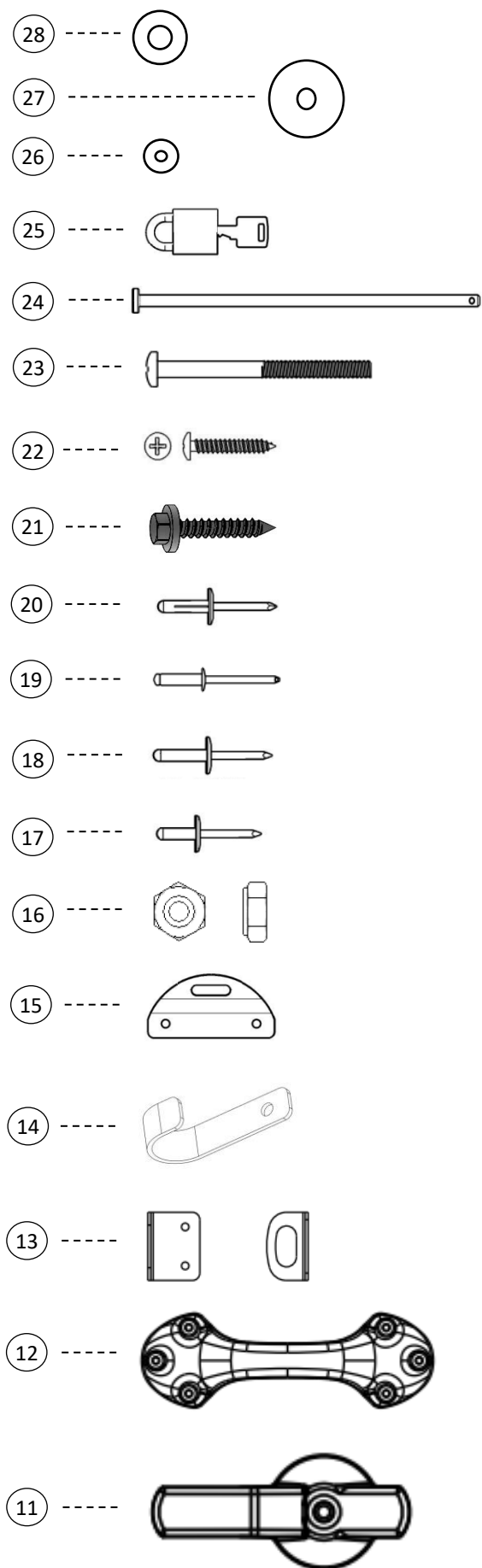

** 23936 HDWE- AXXIS 3 ROLL (BM)

ITEM	PART#	QTY	DESCRIPTION
28	12382	1	WASHER- 1/4 FLAT STNLS
27	11360	1	WASHER- 1/4 ID FENDER STNLS
26	11315	61	WASHER- 3/16 RIVET STNLS
25	1038-699	1	PADLOCL (55/25) W/KEY (5253)
24	1051-699	1	TOILET PAPER ROD FOR 3 ROLL
23	40052	1	SCREW- 1/4-20 x 3-1/2 PH PHHD SS
22	18098	1	SCREW- #10 X 2 PN PH TAP
21	13860	27	SCREW- #14 X 1-1/2 W/WSH GOLD
20	22604	12	RIVET- TRI- LOBR X 5/8 LF
19	11270	4	RIVET- #68 STNLS
18	11054	20	RIVET-#68 AAL POP
17	11030	37	RIVET- #66 AAL POP
16	16307	1	NUT- 1/4-20 NYLOC STNLS
15	1093-699	1	LOCK BRACKET (AXXIS)
14	10891	1	HOOK- FLAT COAT STNLS
13	22605	1	HASP- LARGE LOCK EXTENDED
12	22522	1	HANDLE- PLASTIC LIFT DGRY
11	40057	1	HANDLE- GB TOILET GREY
ITEM	PART#	QTY	DESCRIPTION

**	23936	1	HDWE- AXXIS 3 ROLL (BM)
10	14133	1	VENT PIPE- 4 X 63 DGRY
9	22919	1	URINAL- AX-VN DGRY
8	22918	1	TANK- AX 60 GAL BLOW DGRY
7	10570	1	SEAT- TOILET TUF/FRE/LIB BLACK
6	22920	1	ROOF- AXXIS T-11 DOME NAT
5	22917	1	HOOD- PGRD AX/VN 3 ROLL DGRY
4	23057	3	DESIGN- AXXIS PANEL
3	23935	1	DESIGN- AXXIS FRONT ASSY (BM)
2	22989	2	CORNER MOLDING- WHITE PUNCHED
1	10034	1	BASE ASSY- IMPACT
ITEM	PART#	QTY	DESCRIPTION

Step 1) Assemble 3 Panels:

Tip: Place rear panel flat on table with 44.00" height & 40.00" width, Gaylord box with pallet (may receive with shipment of unit parts), or 2 unit tanks during assembly.

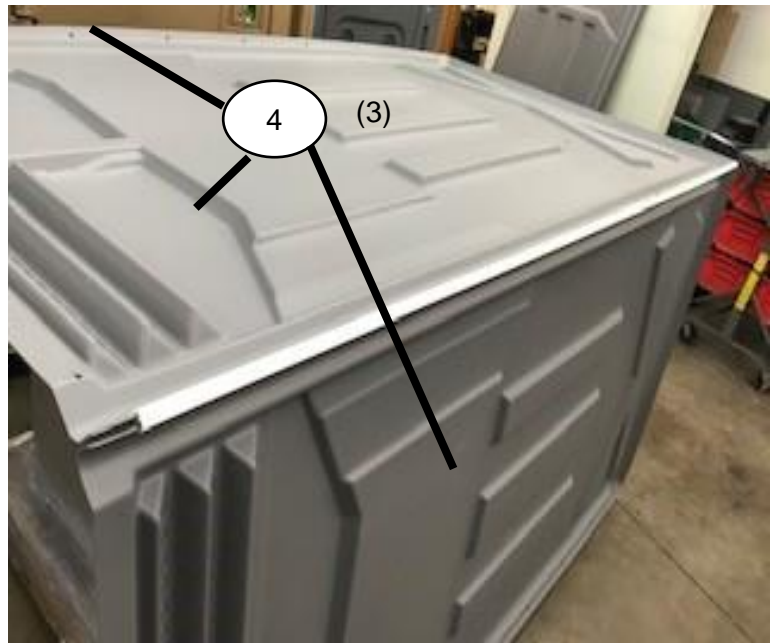
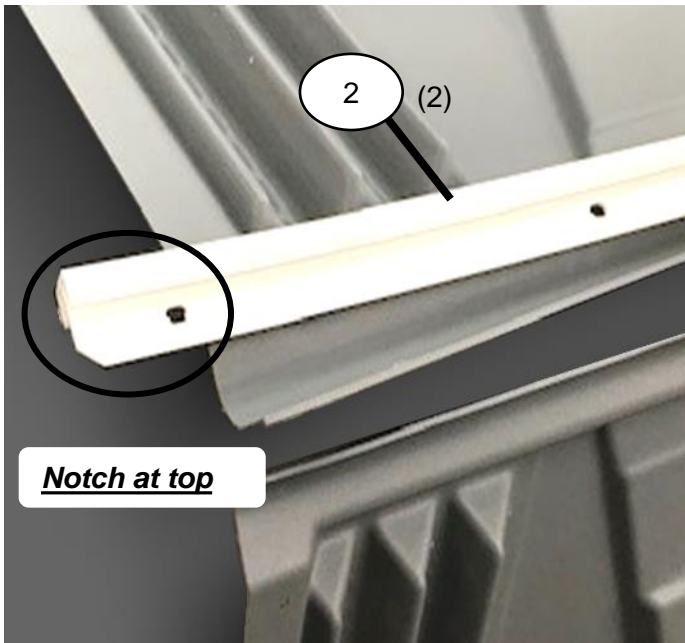

Install Corner molding #22989 between the side panels & rear panel (notched end of corner molding at top of panels).

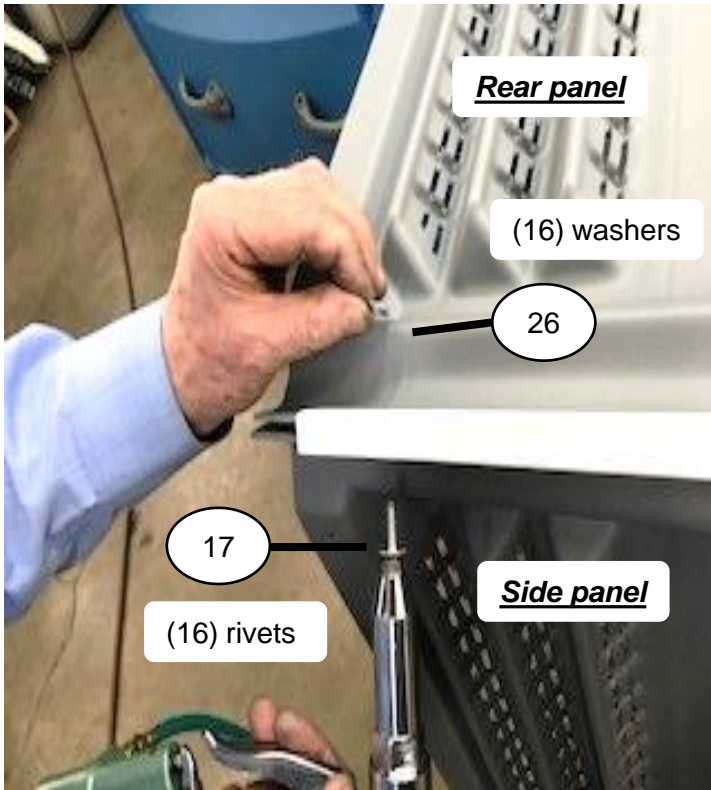

Fasten side panels to rear panel using (16) Rivets #11030 and (16) Washers #11315 (so rivet head is towards the front of unit & washer is towards rear of unit).

Step 2) Assemble 3 panels to base:

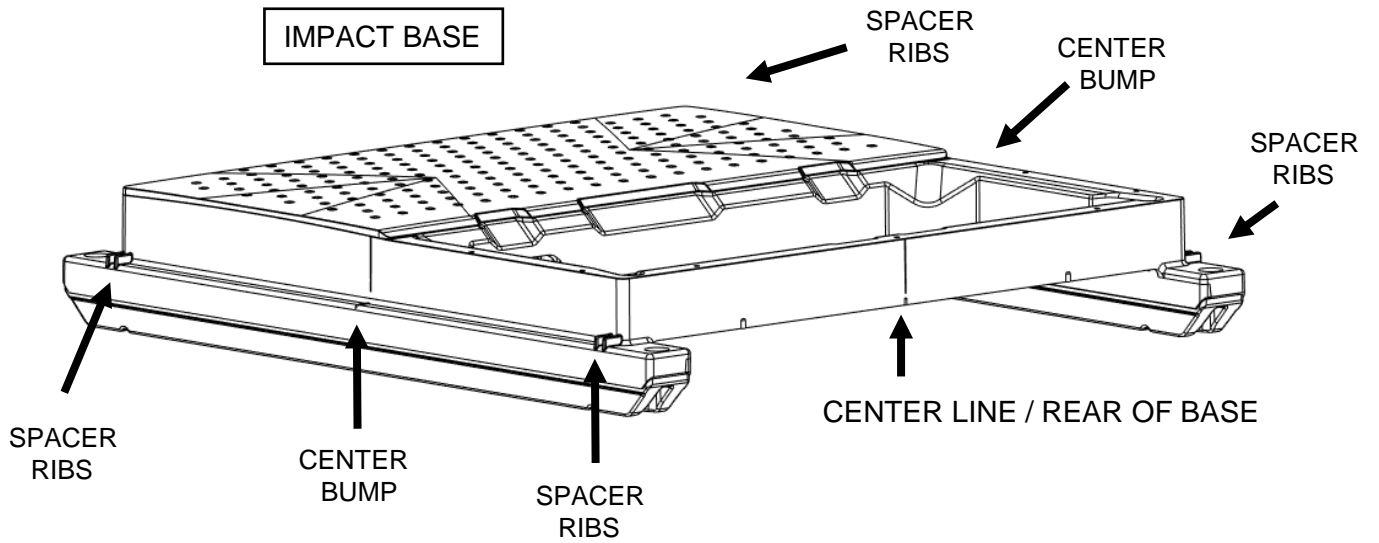

Place base at bottom of 3 assembled panels with tank opening upward towards rear panel as shown. ***Start with either side panel, with bottom edges of side panels resting on spacer ribs near ends of base runners.***

Step 2) Assemble 3 panels to base (continued):

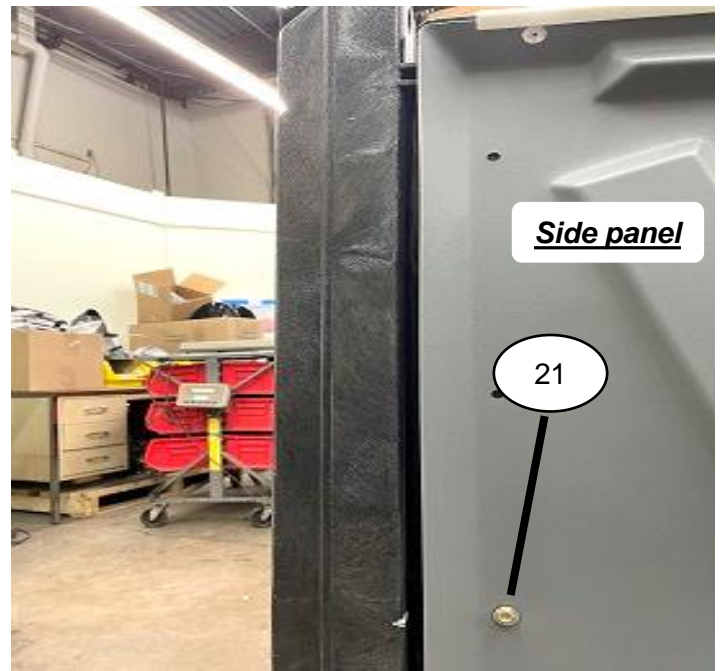
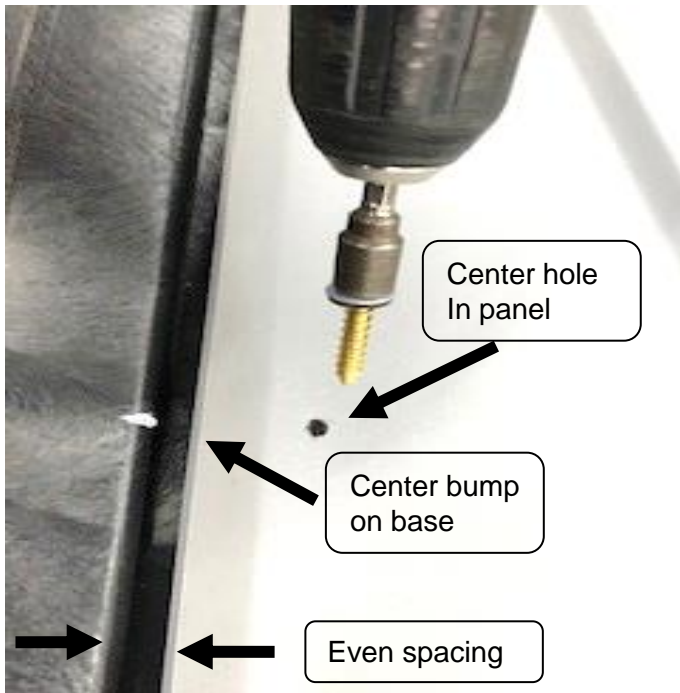

Align center hole in side panel with center bump on top of the runner. The spacing between the panel & top of runner must be even along the entire length of runner with panel . Install Screw #13860 in center hole of panel into base using 3/8" Nut Driver bit. **(DO NOT over tighten screws, run screws in until rubber washer begins to flatten).**

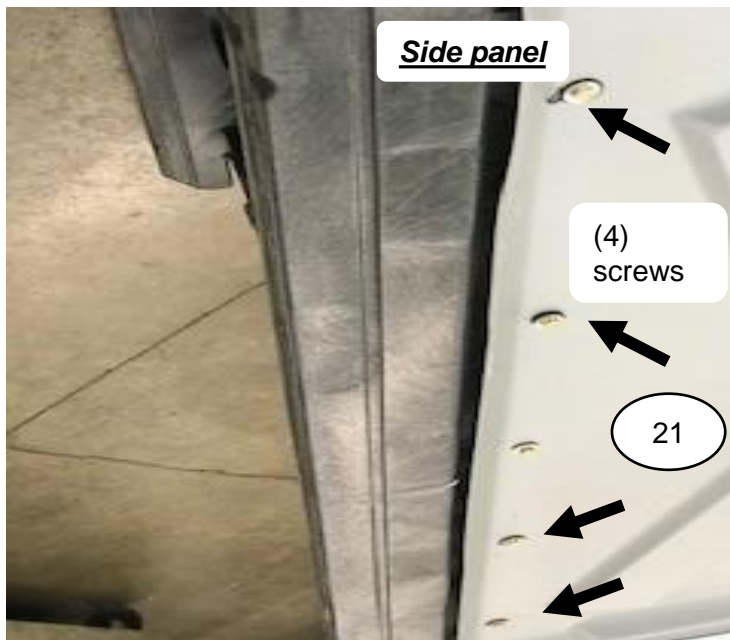

Install (4) remaining screws #13860 in holes on side panel into base, using a 3/8" Nut Driver bit. Repeat sequence on opposite side panel.

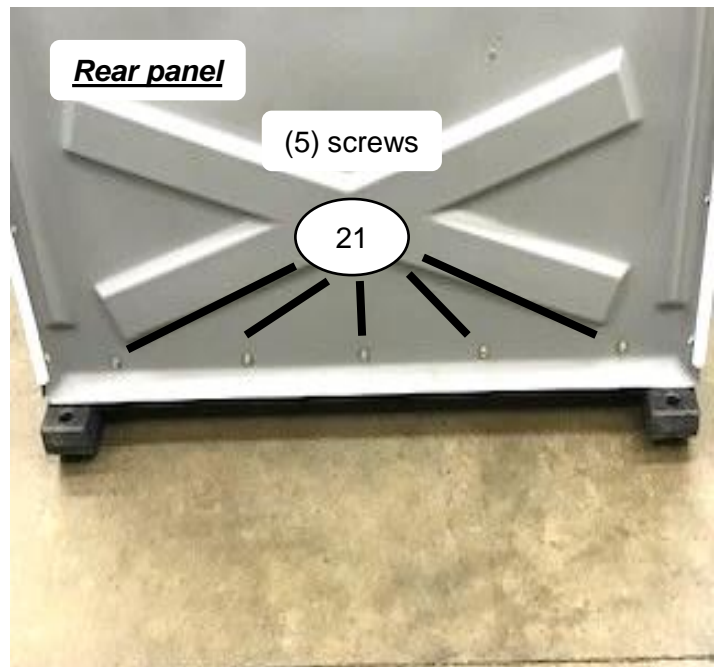

Rear panel, make sure center hole in panel is inline with center line at rear of base. Install (5) screws #13860 in 5 holes in bottom of panel into base using of 3/8" Nut Driver bit.

Step 3) Assemble tank to Panels:

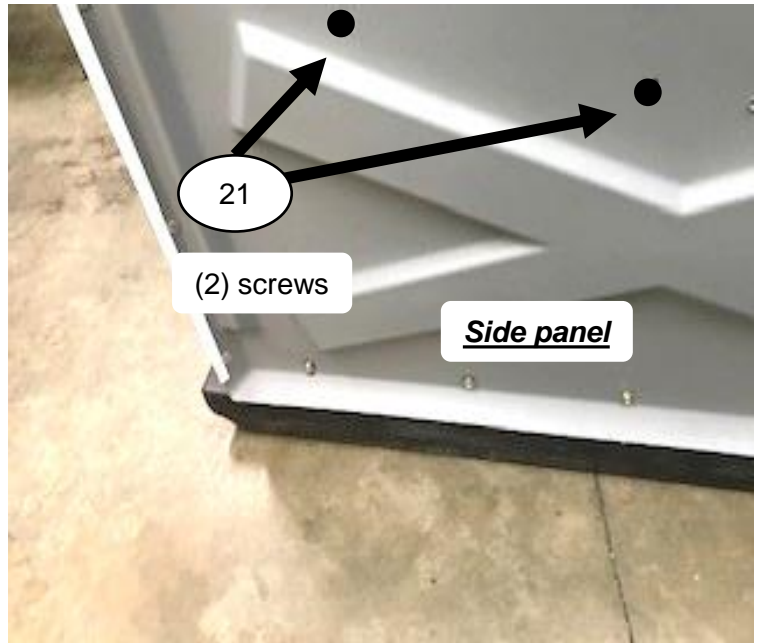

Place tank with seat area level when in base & down tight in base (*have someone sit on tank*). Locate 2 dimples in lower section of side panel as shown. Install (2) Screws #13860 through dimples into tank using 3/8" Nut Driver bit. Repeat sequence for other side panel. **(DO NOT over tighten screws, run screws in until rubber washer begins to flatten).**



Locate 2 dimples in lower section of rear panel. Install (2) Screws #13860 through dimples into tank using of 3/8" Nut Driver bit.

Step 4) Assemble Urinal to panel:

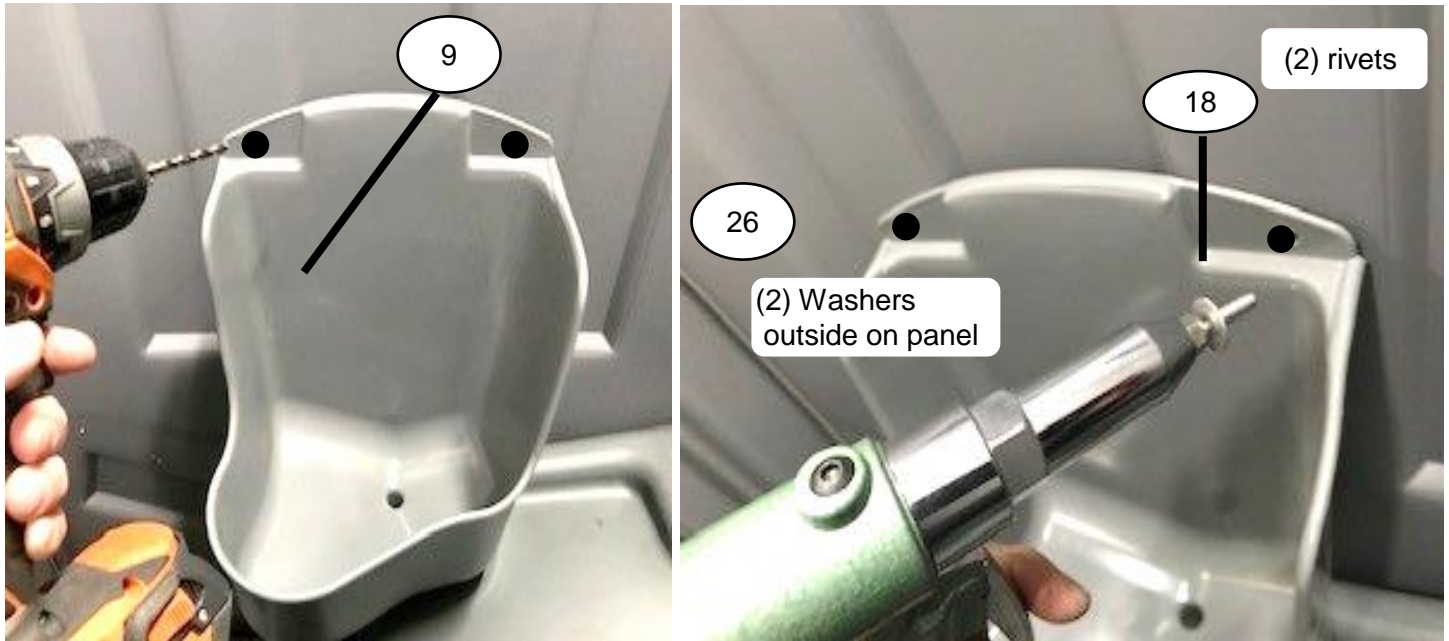

Place Urinal #22919 drain tube in pre-drilled hole in left front corner of tank, with drain tube as far to the front of the tank as possible. *If tank does not have a urinal hole in left front corner, use a 1.00" hole saw at drill point in tank.* Hold urinal level against the left panel & transfer drill in center of recessed tabs at top of urinal (left & right side) through panel using #10 Drill Bit. Fasten urinal to panel, use (2) Rivets #11030 inside through holes drilled in urinal / panel & (2) Washers #11315 outside on panel.

Step 5) Assemble Paperguard hood to panel:

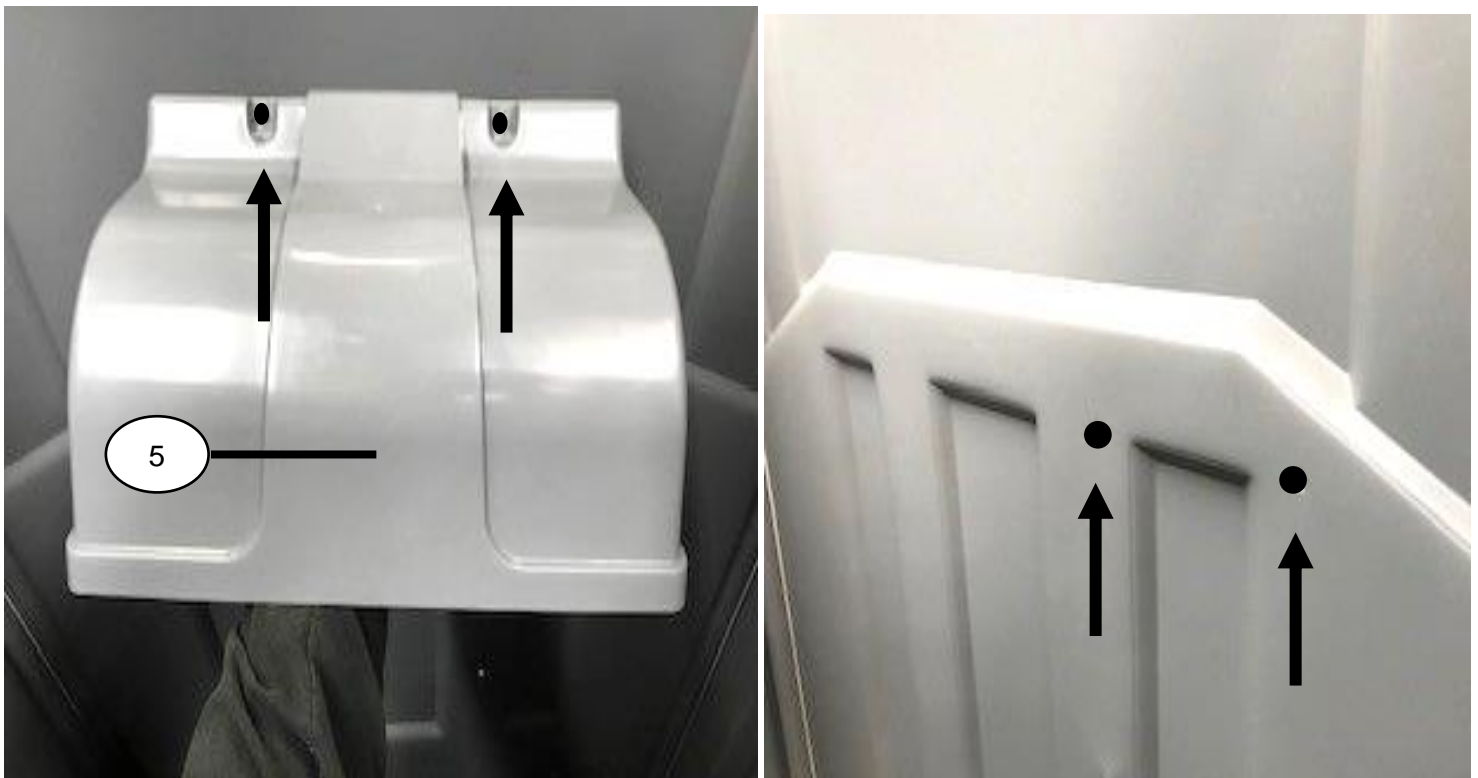

Drill out 2 dimples in top recess tabs in Paper Guard hood #22917 using #10 Drill Bit.
Drill out 2 dimples in right panel using #10 Drill Bit.

Step 5) Assemble Paperguard hood to panel (continued):

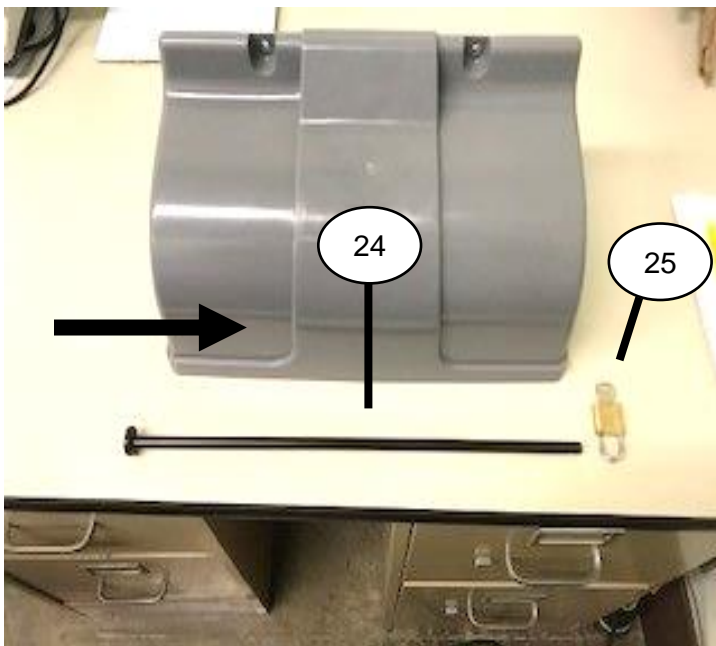

Install toilet paper rod #1051-699 in Paper guard hood from left to right end with hole in first. Place Padlock #1038-699 on end hole (out from right side of Paper guard hood). Fasten Paper guard hood to panel, use (2) Rivets #11030 inside through holes drilled in top of Paper guard hood into holes in panel & (2) Washers #11315 outside on panel.

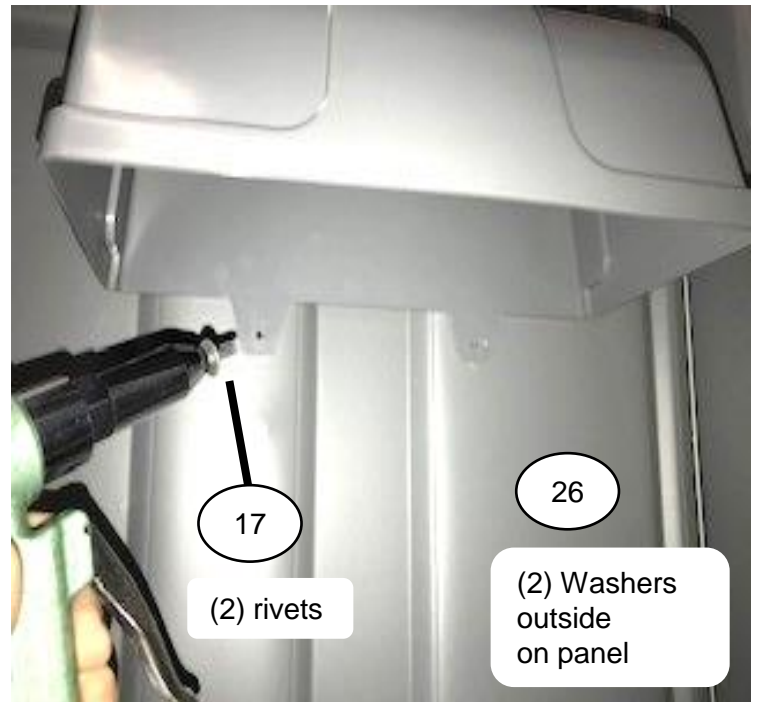

Drill out in center of bottom tabs in Paper Guard hood through panel using #10 Drill Bit. Fasten urinal to panel, use (2) Rivets #11030 inside through holes drilled in urinal / panel & (2) washers #11315 outside on panel.

Step 6) Assemble Front to Side Panels:



Tip unit up on base & place front against side panels with edge of panel tucked in groove on inside edge of front. Align holes in front with holes in panels & use 1 rivet #11054 on front & 1 washer #11315 on panel in middle in holes on left & right side of front.



Tip unit onto rear panel & finish riveting front to panels using rivets (16) #11054 on front & (16) washers #11315 on panel.

Step 7) Assemble Front to base:

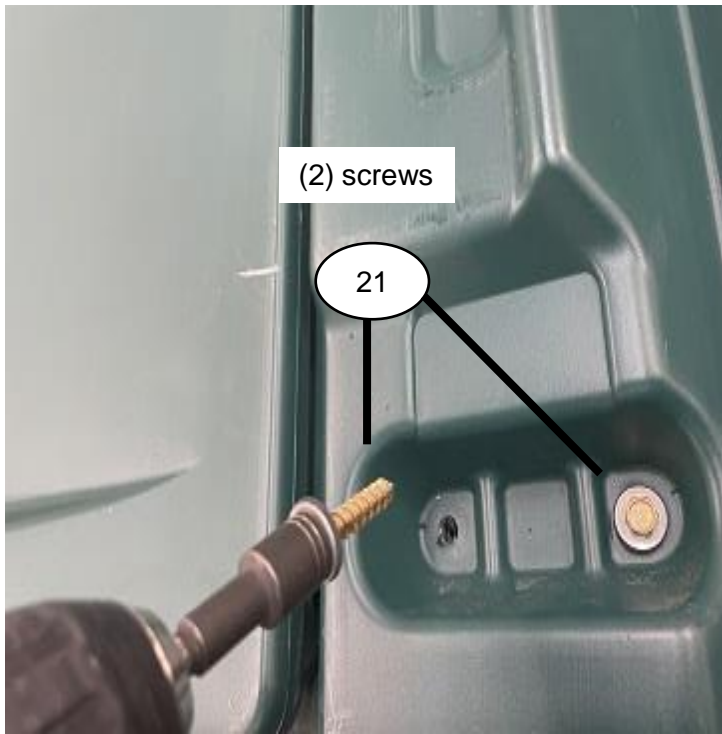

Install (2) Screws #13860 in holes on left & right side of front (door frame) at bottom, using a 3/8" or 5/16" Nut Driver bit **(DO NOT over tighten screws, run screws in until rubber washer begins to flatten).** Remove 4 screws in shipping strap at bottom of door & right door frame with Phillips driver bit.

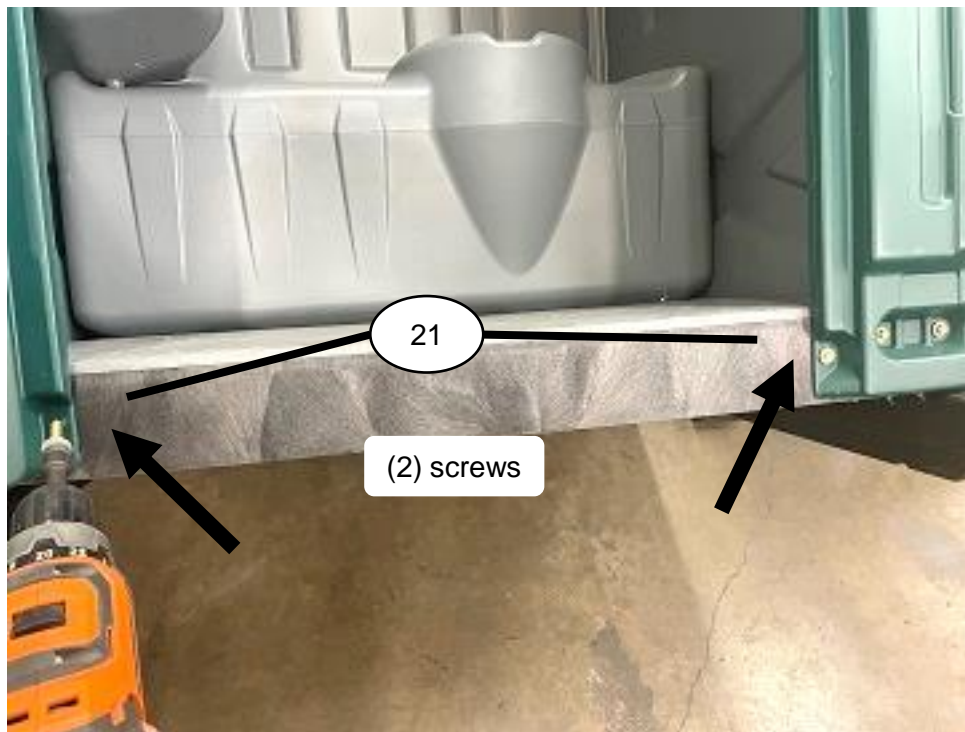

Open door Install Screws #13860 in holes on left & right side of door frame at bottom, using a 3/8" or 5/16" Nut Driver bit **(DO NOT over tighten screws, run screws in until rubber washer begins to flatten).**

Step 8) Assemble lock bracket, hasp to Front:

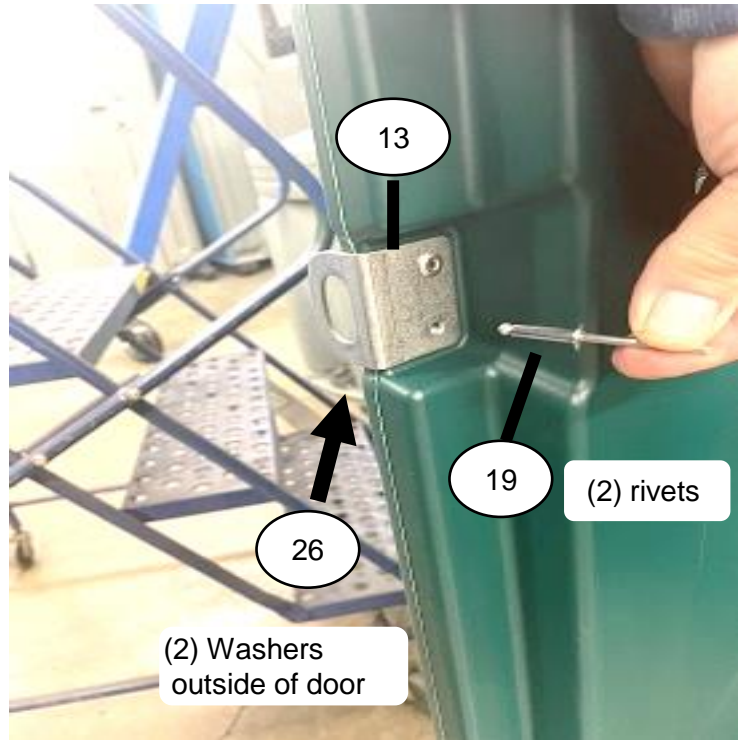

Install Lock bracket #1093-699 on right door frame with angle in Lock bracket away from edge of door frame. Use (2) Rivets #11270 through bracket holes into pre-drilled holes door frame & (2) Washers #11315 on inside of door frame on rivets. Install hasp #22605 on inside of door. Use (2) Rivets #11270 through bracket holes into pre-drilled holes door & (2) Washers #11315 on outside of door on rivets .

Step 9) Assemble Coat hook to Front:



Drill dimple at top inside of front with #10 Drill bit. Rivet Coat #hook to front using rivet #22604.

Step 10) Assemble Handle Front:

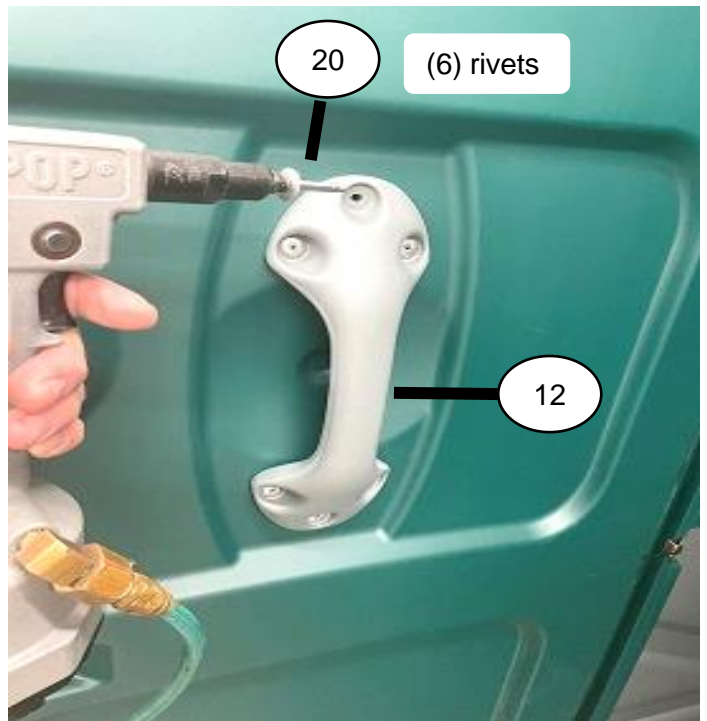

Rivet Handle #22522 to inside of door in 6 pre-drilled holes using rivet #22604.

Step 11) Assemble Handle (door latch) Front:



Place Handle #40057 on inside of door (recessed area).

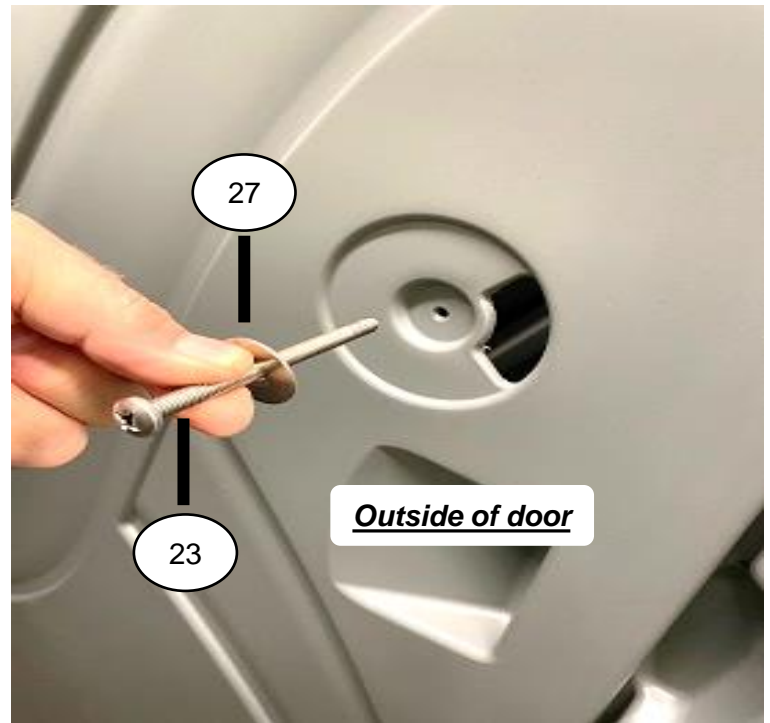

From outside door insert screw #40052 (3-1/2") with washer #11360 in hole in door through hole in handle

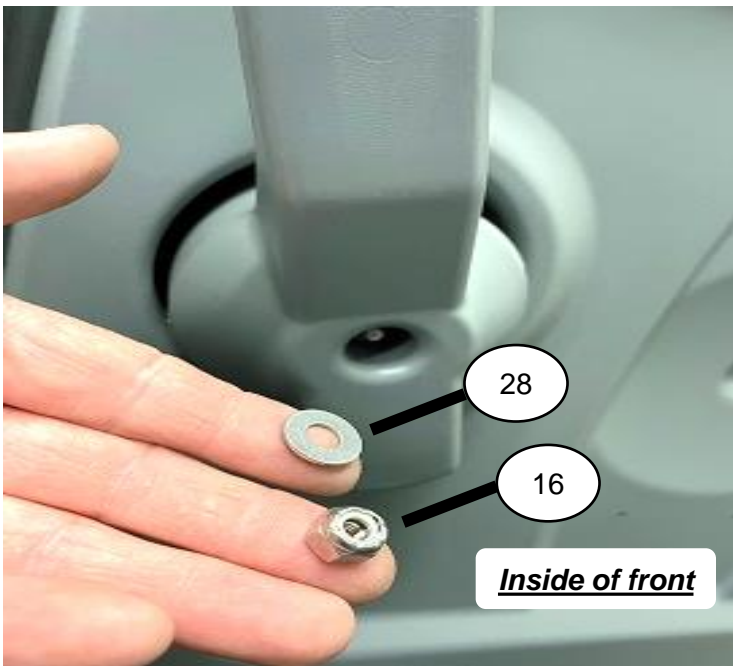

Inside of door. Place washer #12382 & nut #16307 on screw into recess of handle. Tighten screw/nut using #2 Phillips Head Driver Bit & 7/16" HEX NUT DRIVER or DRIVER BIT. Tighten screw / nut so handle is snug & not so loose that it could fall to closed position.

Step 12) Assemble vent pipe to tank:

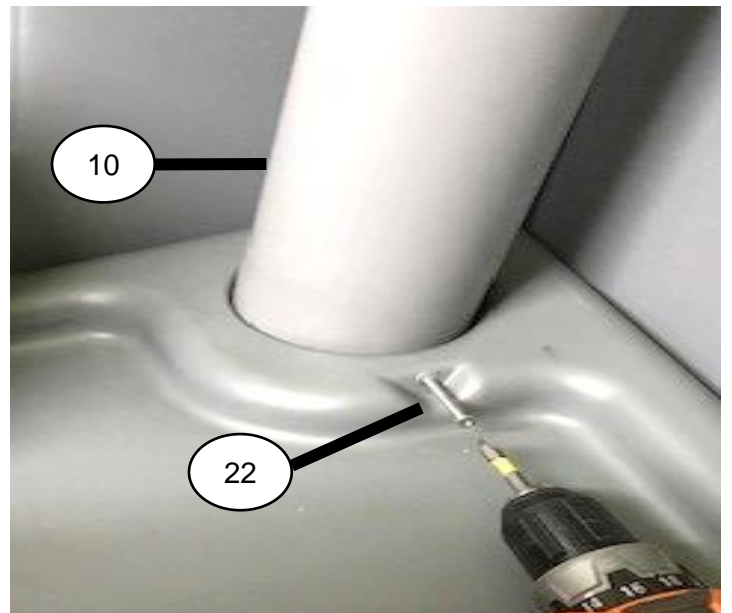

Install vent pipe #14133 in left rear corner of tank. Make sure vent pipe is seated completely in tank. Install screw #18098 in recess shown on tank, using Phillips driver bit. Make sure screw is level when installing in tank through to vent pipe.

Step 13) Assemble seat-lid to tank:



Install Seat-lid #10570 on tank with plastic screws & nuts (included with the seat-lid).

Step 14) Assemble Roof to panels : (T-11 roof shown, T-22 roof is installed the same).

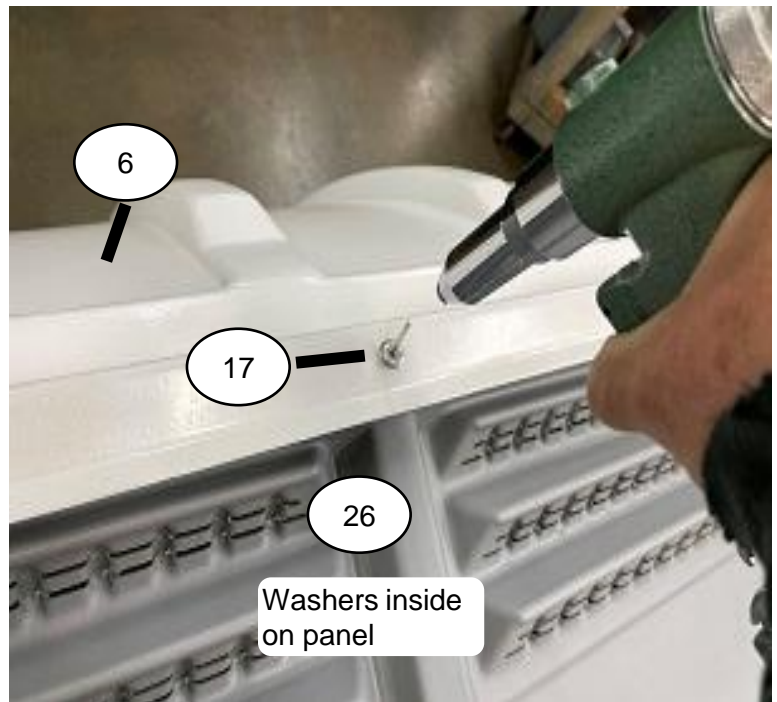

Start on sides of roof at center hole location. Fasten roof to side panel using Rivet #11030 outside on roof & Washer #11315 inside on panel. Repeat sequence to assemble roof to other side panel.



NOTE: Front Hole location on each side of roof there may not be a hole drilled in roof. Hold roof down & transfer drill from inside through hole in panel.

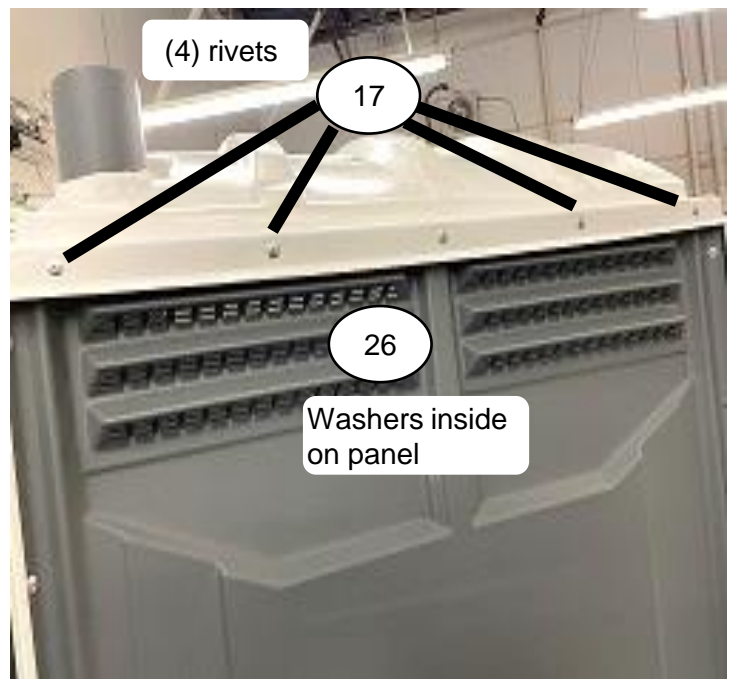

Finish fastening roof to side panel with (4) Rivets #11030 outside on roof & (4) Washers #11315 inside on panel. Repeat sequence to assemble roof to other side panel.

Step 14) Assemble Roof to panels (continued):

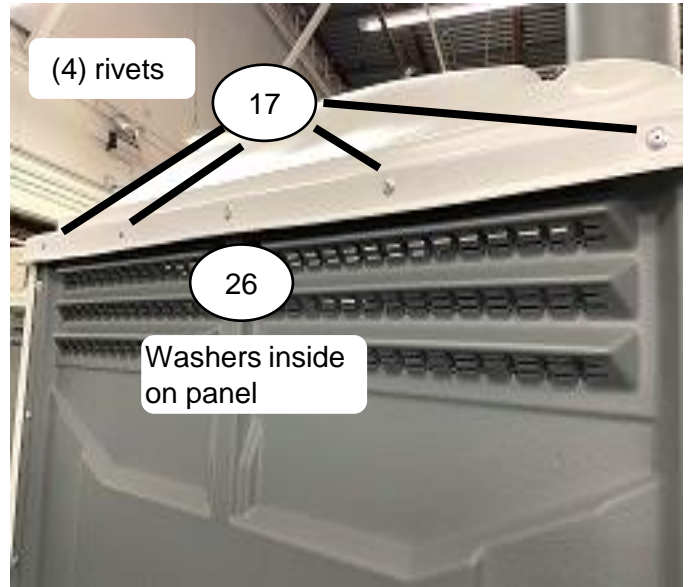
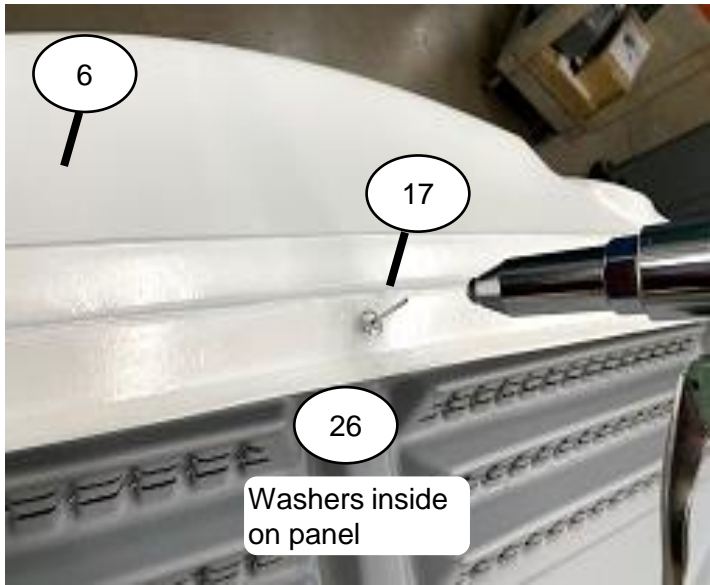

At rear of roof start at center hole location. Fasten roof to rear panel using Rivet #11030 outside on roof & Washer #11315 inside on panel.

Finish fastening roof to rear panel with (4) Rivets #11030 outside on roof & (4) Washers #11315 inside on panel.

Step 15) Assemble Roof to front:

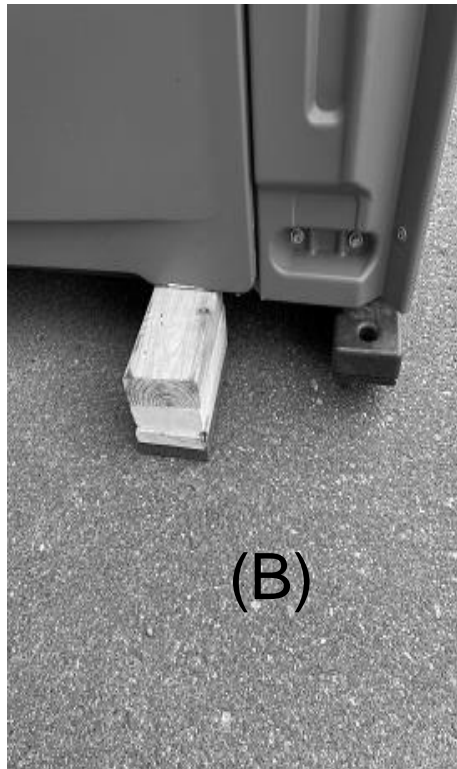
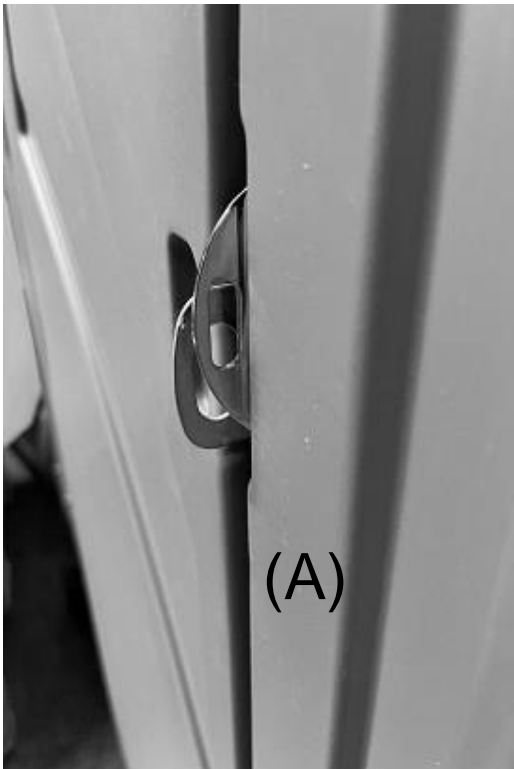

Before fastening roof to front check that there is no major door sag as seen in see pic (A), door hasp way down from hasp on right facing & gap at top of door between door & door frame is greater on right side than the left side. Place block of wood (4-1/2" height recommended) under bottom right corner of door **ONLY** not under base see pic (B). This will lift door up & hasps should be in lined up as seen in pic (C). Then fasten roof to front following Step 15)

Step 15) Assemble Roof to front continued:



Push down on roof tight against front door frame. Transfer drill through 5 holes in roof through Front using #10 Drill bit .**Caution only drill through first wall of door frame.** Starting with center hole fasten Roof to Front with Rivets # 22604



Finish fastening roof to front with (4) Rivets #22604.



2530 Xenium Lane North, Minneapolis, MN 55441
Telephone: 763-553-1900 Fax: 763-553-1905
800-328-3332 / www.satelliteindustries.com